

 II 2019G Ex Ib IIC/ IIB T4
 PTB 11 (1) D IEX Ia DaI IIC
 Ex Ib IIC/ IIB T4
 IEX Ia DaI IIC
 IEX Ia DaI IIC

The brochure was put together carefully in conformance to the current status of standards and regulations. The respective amended version of the technical and statutory rules is binding. Errors and misprints do not justify any claim for damages.
 All rights reserved, in particular the rights of duplication, distribution and translation.

BARTEC brochure "Basic concepts for explosion protection"
 13. revised edition - Version 2018
 Authors:
 Dr.-Ing. Hans-Jürgen Linström
 Dipl.-Ing. Johannes Buhn

CONTENT

TECHNICAL DEVELOPMENT OF EXPLOSION PROTECTION	2 - 3	TYPES OF PROTECTION	20 - 31
EXPLOSION PROTECTION	3 - 7	General requirements	20
Explosion	3	Types of protection to electrical equipment	21
Basis for an explosion	3	Types of protection to non-electrical equipment	22
Three factors	4 - 6	Increased safety	Ex eb 23
Flammable material, oxygen, sources of ignition		Non-sparking device	Ex ec 23
Hazardous area	6	Constructional safety	c/Ex h 23
Prevention of explosions	6	Intrinsically safe	Ex ia, ib, ic 24
Primary explosion protection	7	Control of ignition sources	b/Ex h 24
Secondary explosion protection	7	Encapsulation	Ex ma, mb, mc 25
Tertiary explosion protection	7	Non-incendive component	Ex nC 25
		Encapsulated device	Ex nC 26
		Sealed device	Ex nC 26
		Hermetically sealed device	Ex nC 26
SECONDARY EXPLOSION PROTECTION	8 - 19	Oil, /Liquid immersion	Ex o, k/Ex h 27
Relevance and advantage of the area classification in workplaces	8 - 9	Pressurized enclosures	Ex px, Ex py, Ex pz 28
Explosion parameters	10	Restricted breathing enclosure	Ex nR, fr 28
Ignition temperature	10 - 11	Protection by enclosure	Ex ta, tb, tc 29
Gases/vapours temperature class		Flameproof enclosures	Ex da, db, dc 30
Ignition temperature from dusts (layer and cloud)		Enclosed break device	Ex nC 30
Explosion sub-group	12 - 13	Powder filling	Ex q 31
Maximum experimental safe gap (MESG)		Special protection	Ex s 31
Minimum ignition current ratio (MIC)			
Conductivity of the dust			
Protection principles	14	MARKING	32 - 35
Design regulations and prevention of effective sources of ignition in devices	15	Marking in accordance with Directive 2014/34/EU, IEC and EN standards	32
Standards for explosion protection	16 - 19	Application areas – equipment categories – equipment protection level	33
		Examples of marking for electrical equipment and non-electrical equipment	34 - 35
		CONFORMITY	36 - 37
		ATEX Conformity (CE)	36
		IECEx Conformity	37
		Comparison of the ATEX and IECEx system	38

TECHNICAL DEVELOPMENT OF EXPLOSION PROTECTION

Unwanted ignitions are older than mankind. Atmospheric discharges – lightning – triggered fires long before humans walked the earth. In 1753 the first lightning conductor was invented, enabling electrostatic hazards as the sources of ignition for fires to be significantly reduced. Lighting in mining also constituted another high fire risk for many years, because mine air mixed with methane – so-called firedamp – was able to cause explosions when sufficiently strong ignition sources were present. In 1815 Sir Humphry Davy introduced the first mine safety lamp, a non-electrical item of equipment for mining. Two wire glass screens arranged on top of each other separated the flame - which was to be kept as small as possible inside the screen - from the flammable mixture present, while allowing combustion inside the screen. When used correctly, the screens prevented external ignition, however.

In the 19th century, electrical equipment was introduced into industry and households. Immediately afterwards, the occurrence of methane and coal dust in hard coal mining prompted the development of the basics of electrical explosion protection. The advantages of electricity were so convincing that intensive work was carried out to find a way to reliably prevent contact between an explosive atmosphere and ignition sources - originating from the use of electrical equipment - and thus prevent explosions.

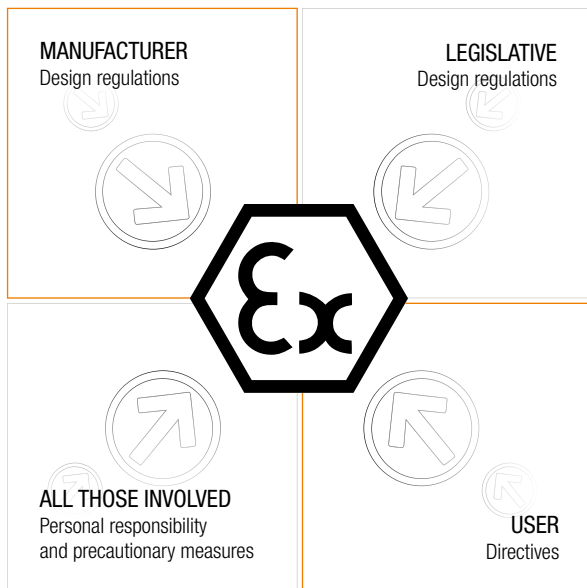

Figure 1

After bitter experiences in the beginning, the occurrence of firedamp explosions was greatly reduced and well-monitored electrical equipment was utilised with very high safety standards.

Today, fortunately, the number of accidents caused by electrical ignition sources is low. The expenditure on development and manufacturing and the statutory regulations have proven to be successful and the frequently posed question as to “whether such expenditures are justified” must be answered with yes. Any neglect would equal culpable carelessness. Unfortunately there are still numerous examples of explosions that demonstrate the devastating effects on humans, environment and plants.

Solutions concerning sources of ignition are referred to as secondary explosion protection and priority is given to what is regarded as primary explosion protection, i. e. the focussing of attention on the use of non-flammable substances that are not capable of forming an explosive atmosphere.

However, it is not always possible to exclude flammable substances such as methane or coal dust in mines, or petrol and in future perhaps hydrogen in vehicles. In such cases protection and safety are provided by equipment which is reliably explosion proof.

These days, the construction of explosion proof equipment goes far beyond the field of electrical engineering. As will be demonstrated in the further descriptions, in future non-electrical equipment will also require testing or at least assessment. Here the knowledge gained by manufacturers over the decades on the explosion proof electrical equipment is particularly important and it now also benefits the manufacturers of non-electrical equipment. These manufacturers often buy electrical equipment, which automatically creates a contact.

There are many applications which require explosion proof equipment. During the over 100 years of electrical explosion protection, principles and techniques have been developed which allow the use of electrical measuring technology, even where, e. g. in reaction vessels, an explosive atmosphere is permanently present.

The applications in the mining area were the beginning. The utilisation and processing of mineral oil and natural gas offer a wide scope for using explosion proof equipment. Organic chemistry, the paint industry and the pharmaceutical industry all process flammable liquids and gases. Because of the production and utilisation of biogas and the ecological utilisation of waste dumps, new applications are constantly developing. The utilisation of hydrogen is being discussed in depth, practised in experimental installations and exhibited at trade fairs.

Harmonisation of explosion protection

Internationally, the standpoints on the explosion protection of electrical and non-electrical devices are co-ordinated by specialised IEC and ISO working groups nowadays. In the area of electrical engineering, internationally harmonised design regulations were formulated in IEC standards at a very early stage. For the most part, this was done in conformance with the CENELEC standards. A visible sign of the harmonisation is that the relevant IEC/ISO World, EN Europe and DIN EN Germany documents on standards agree in content and in the registration number (IEC 60079 ff). Harmonisation is being worked on intensively at present. This reorganisation involves continuous amendments but will also make future international work easier. ISO/IEC working groups analogously adapt the standards from the explosion protection of electrical operating equipment (ISO 80079-36, 37) for application to non-electrical devices also.

Under the IECEx system, electrical devices are developed and tested and certified with a conformity certificate (IECEx CoC) in accordance with the internationally uniform requirements (IEC/ISO standards) and the same will be done with assembly groups and non-electrical devices in future too.

However, certificates are still accepted on the basis of regional (e.g. in Europe with the manufacturer’s EU Declarations of Conformity) and local (e.g. Brazilian INMETRO certificates, USA UL/FM certificates etc.) statutory and insurance law regulations. It is often necessary to introduce amendments, e.g. new certification, to conform to national requirements. In international projects, it is therefore important to engage with the users to clarify the details of the specifications with respect to the explosion protection requirements.

With ATEX Directive 2014/34/EU (previously 94/9/EC), the European Community has provided itself with binding uniform feature requirements relating to the explosion protection of systems, devices and components and these are

supported by harmonised EN standards from the CENELEC and CEN standardisation committees.

With the help of these standards, the manufacturer can assume during the design and assessment of the explosion protection that he is developing safe, explosion-protected systems, devices and components in compliance with Atex Directive 2014/34/EU, which will then be tested in conformance to uniform and binding inspection processes by an EU-authorized notified body. If the test criteria have been met successfully, the test bodies notified in the EU issue the EU-type examination certificates which ensure fulfilment in Europe of the uniform characteristics with respect to the required safety of the explosion-protected equipment with the highest or increased safety level. These EU-type examination certificates or assessments carried out by the manufacturer are a prerequisite for the production and the placing on the market of systems, devices and components with very high and enhanced safety levels.

A uniform classification of hazardous areas (installations) provides a basis for selecting and assigning systems and devices including their installation. Under EU Directive 1999/92/EC, an explosion protection document is a precondition for setting up and operating a potentially explosive facility. Only such a document makes it possible to select systems, devices and components with respect to explosion protection and to install, operate, maintain and eventually repair them in compliance with standards. The corresponding technical rules and regulations are drawn up and adopted on a national level.

Directive 2014/34/EU accordingly formulates EU-wide uniform construction requirements for devices used in hazardous areas while Directive 1999/92/EC contains the minimum requirements, which can be increased nationally. Using the two above directives creates a closed system which makes it possible to prevent explosions reliably in order to protect people, the environment and property effectively.

EXPLOSION PROTECTION

Explosion

Als Explosion bezeichnet man eine plötzliche, d. h. mit großer Reaktionsgeschwindigkeit ablaufende, Oxidations- oder Zerfallsreaktion, die eine Temperatur- oder Druckerhöhung oder beides gleichzeitig erzeugt. Am bekanntesten sind Reaktionen brennbarer Gase, Dämpfe oder Stäube mit dem Sauerstoff der Luft.

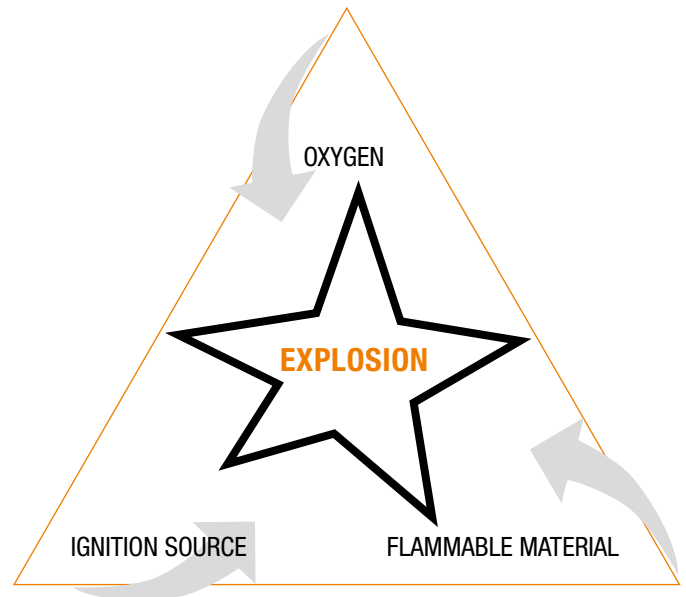

Figure 2

Basis for an explosion

As a rule, for explosions to happen in atmospheric air, three factors have to be present at the same time:

- flammable material
- oxygen (air)
- source of ignition

In production and work places, hazardous areas can develop wherever the first two preconditions for an explosion are fulfilled. Typical hazardous areas form in chemical factories, refineries, enamelling plants, paint workshops, cleaning equipment, mills and stores for milled products and other combustible dusts, in tank facilities and loading areas for flammable gases, liquids and solids.

The first two factors - the flammable substance and air - must be present in sufficient quantities to form an explosive atmosphere. The statutory definitions of explosion protection - derived from the health and safety at work regulations - are concerned with workplaces. For this reason, explosion protection is generally limited to description of reactions with oxygen in the air. Oxidation reactions normally involve increases in heat and pressure and therefore fulfil the criteria of an explosion.

It is generally assumed that a volume of 10 l of an explosive mixture in an enclosed space can cause damage - particularly to people. For this reason, any area in which such a volume of an explosive mixture can collect is described as a potentially explosive atmosphere.

Other compounds such as chlorine in reaction with hydrogen are also capable of forming explosive mixtures and have already led to explosions in the past. However, as these reactions usually take place inside containers or reactors, they concern the safety of these facilities and their effects on the environment are therefore dealt with in the EC machinery directive and incident analysis.

Three factors

Flammable material

Flammable material can be gaseous, liquid or solid. For a general discussion relevant to work places, their reactivity with atmospheric oxygen is considered.

■ Flammable gases

A flammable gas may be an element such as hydrogen which can be made to react with oxygen with very little additional energy. Flammable gases are often compounds of carbon and hydrogen. These flammable gases and **vapours** require only small amounts of energy to react with atmospheric oxygen.

A vapour is the proportion of a liquid - if talking about the explosion protection of flammable liquids - which has evaporated into the surrounding air as the result of the vapour pressure above the surface of the liquid, around a jet of that liquid or around droplets of the liquid. Mist is a special type, which because of its explosion behaviour, can be included with the vapours, for the purposes of fulfilment of safety considerations.

■ Flammable liquids (Vapour)

Flammable liquids are often hydrocarbon compounds such as ether, acetone or petroleum spirit. Even at room temperature, sufficient quantities of these can change into the vapour phase so that an explosive atmosphere forms near their surface. Other liquids form such an atmosphere near their surface only at increased temperatures. Under atmospheric conditions this process is strongly influenced by the temperature of the liquid.

For this reason the **flash point**, or rather the flash point temperature, is an important factor when dealing with flammable liquids. The flash point relates to the lowest temperature at which a flammable liquid will, under certain test conditions, form a sufficient quantity of vapour on its surface to enable an effective ignition source to ignite the vapour air mixture.

The flash point is important for the classification of potentially explosive atmospheres. Flammable liquids with a high flash point are less dangerous than those with a flash point at room temperature or below.

When spraying a flammable liquid, **a mist** can form consisting of very small droplets with a very large overall surface area, as is well-known from spray cans or from car spraying stations. Such a mist can explode. In this case the flash point is of lesser importance. For a fine mist - made from a flammable liquid - the behaviour relevant to safety can be roughly derived from the known behaviour of the vapour.

■ Flammable solids (Dusts)

Flammable solids in the form of **dust** or **flyings** can react with atmospheric oxygen and produce disastrous explosions. Normally more energy is required for activating the explosion in air than with gases and vapours. However, once combustion starts, the energy released by the reaction produces high temperatures and pressures. In addition to the chemical properties of the solid itself, the fineness of the particles and the overall surface area, which increases with increasing fineness, play an important part. The properties are processes which take place immediately at the surface of the solid. Lighting and extinguishing a paraffin wax candle provides a demonstration of a series of processes undergone by a solid material within a short period of time which cannot easily be presented in a simplified form.

An experiment shows that when the wick of a candle is lit, the paraffin wax melts and then vaporises and that this vapour feeds the flame. After extinguishing the candle, the paraffin vapour can still be smelled, the melted paraffin wax solidifies and the paraffin vapours disperse. Now the paraffin wax candle is once again a harmless object.

Dust reacts very differently, depending on whether it is in a deposited layer or whether it is in a suspended dust cloud. Dust layers are liable to begin smouldering on hot surfaces, while a dust cloud which has been ignited locally or through contact with a hot surface can explode immediately. Dust explosions are often the consequence of smouldering dust layers which become stirred up and already carry the ignition initiation. When such a layer is stirred up, for example by mechanical cleaning methods during transportation or inappropriate extinguishing attempts, this can lead to a dust explosion.

A gas or vapour/air explosion can also stir up the dust, which then often leads to the first, the gas explosion, turning into the second, the dust explosion. In deep coal mines methane/firedamp explosions often have triggered off coal dust explosions whose consequences were more serious than those of the original firedamp explosion.

Oxygen

The quantity of oxygen available in the air can only oxidise/burn a certain quantity of the flammable material. The ratio can be determined theoretically, it is called the stoichiometric mixture. When the quantity of the flammable material and the available atmospheric oxygen are near to at the correct ratio, the effect of the explosion - temperature and pressure increase - is most violent. If the quantity of flammable material is too small, combustion will only spread with difficulty or will cease altogether. The situation is similar when the quantity of flammable material is too great for the amount of oxygen available in the air.

All flammable materials have their explosive range, which also depend on the available activation energy. This is usually determined by igniting the mixture with an electric spark. The explosive range is bounded by the lower explosive limit and the upper explosive limit. This means that below and above these limits, explosions will not happen. This fact can be utilised by sufficiently diluting the flammable substances with air or by preventing the ingress of air/oxygen into parts of the equipment. The latter option is, however, not or only with restrictions possible in environments where people regularly work and must therefore be reserved for technological equipment.

Sources of ignition

With technical equipment a large number of ignition sources is possible. In the following overview the numbers given behind the ignition sources refer to the appropriate sections of the basic standard: EN 1127-1: 1997 "Explosive atmospheres - Explosion prevention and protection- Part 1: Basic concepts and methodology."

■ **Hot surfaces (5.3.2)** arise as a result of energy losses from systems, equipment and components during normal operation. In the case of heaters they are desired. These temperatures can usually be controlled.

In the event of a malfunction - for example with overloading or tight bearings - the energy loss, and therefore the temperature, increases unavoidably. Technical equipment must always be assessed as to whether it is stabilising - i. e. whether it can attain a final temperature, or whether non-permissible temperature increases are possible which need to be prevented by taking appropriate measures.

Examples: coils, resistors or lamps, hot equipment surfaces, brakes or overheating bearings

■ **Flames and hot gases (including hot particles) (5.3.3)** can occur inside combustion engines or analysis devices during normal operation and when a fault has occurred. Protective measures are required here which are able to permanently prevent them from leaving the enclosure.

Examples: exhausts from internal combustion engines or particles which are formed by the switching sparks of power switches eroding material from the switch contacts

■ **Mechanically generated sparks (5.3.4)** are produced for example by grinding and cutting devices during normal operation and are therefore not permitted in a potentially explosive atmosphere. Cracks in rotating parts, parts sliding over each other without sufficient lubrication and similar situations can generate such sparks when malfunctioning and this must be carefully considered with respect to faults.

The setting of special requirements for the materials used to make enclosures serves to reduce the risks from such ignition sources.

Examples: tools such as a rusty hammer and chisel in contact with light alloys or the metal fork of a fork lift truck

■ **Electrical apparatus (5.3.5)** must normally be regarded as a sufficient ignition source. Only very low energy sparks with energies of only microwatt seconds may be regarded as too weak to start an explosion. For this reason, suitable measures must be adopted to prevent these ignition sources.

Examples: switching sparks, sparks at collectors or slip rings

■ Electric rails and other earthed voltage supplies e.g. for electric corrosion protection of equipment, can result in **stray electric currents, cathodic corrosion protection (5.3.6)** which then may result in a potential difference between different earthing points. This is why a highly conductive connection to all the electrically conductive parts of the equipment must be provided so that the potential difference is reduced to a safe level. It is not relevant whether the conductive equipment is electrical or non-electrical parts of the installation, as the cause of the current may be found outside of the equipment.

An equipotential bonding must always be provided, irrespective of whether or not such currents are expected or whether its sources are known.

■ Independently of whether or not there is an electrical voltage supply, electrical sparks can be caused by **static electricity (5.3.7)**. The stored energy can be released in the form of sparks and function as an ignition source. Because this ignition source can arise quite independently of an electrical voltage supply, it must also be considered with non-electrical devices and components. It is connected with separation processes; therefore these cases must be assessed where this ignition source needs to be taken into account.

Friction during normal operation can be the cause of electrostatic charging. For example, portable devices cannot - due to their portability - be earthed or connected to an equipotential bonding ring. When interacting with the clothes of the user, static charging can occur during normal operation. Static electricity must be prevented from becoming an ignition source by taking appropriate measures.

Examples: Transmission belts made from plastic materials, enclosures of portable devices, synthetic clothing material.
Separation processes when rolling out paper or plastic film, plastic pipe systems

■ **Lightning (5.3.8)** and the impact of lightning can result in the ignition of an explosive atmosphere. Lightning always results in the ignition of an explosive atmosphere. However, there is also a possibility of ignition due to the high temperature reached by lightning.

Large currents flowing from where lightning strikes can produce sparks in the vicinity of the point of impact.

■ Radio frequency (RF) electromagnetic waves from 10^4 Hz to 3×10^{11} Hz. Among the ignition sources where radiation energy enters the explosive mixture, the following deserve to be mentioned:

Electro-magnetic radiation - radio waves (5.3.9),

Electro-magnetic radiation - IR radiation, visible light (5.3.10),

Ionising radiation - UV radiation (5.3.11),

Ultrasonic (5.3.12).

Systems, devices and components that use radiation may be set up and operated in the Ex area if their parameters are limited permanently and reliably and this equipment is checked.

Examples: transmitting and receiving equipment, mobile telephones, photoelectric barriers and scanners

■ Finally, **adiabatic compression and shock waves (5.3.13)** inside tube-shaped structures operated at negative pressure can also become a source of ignition.

Examples: breakage of a long fluorescent tube in a hydrogen/air atmosphere

Hazardous area

In the internal combustion engine the three factors work together effectively: petrol, air/oxygen and the ignition spark produce an explosion inside the enclosed cylinder. For this to take place, the ratio of petrol to air must be correct. If the petrol tank is empty, the air filter blocked or if the ignition does not work, one of the components for triggering this controlled, useful explosion is missing and the motor will not start.

Combustible materials mixed with air have a lower and an upper explosive limit and the explosive range lies between these limits. When considering the safety of the workplace, the lower explosive limit is the more important value. In many cases, a possible concentration $\leq 20\%$ of this value which is verifiably constant or continuous is considered to be safe.

Prevention of explosions

Explosion proof equipment is able to exclude one of the preconditions for an explosion - the ignition source - and is in that way an important contribution to explosion protection. In domestic areas, constructional measures ensure that normally an explosive atmosphere cannot form. The conscious restriction of these measures, e. g. the intended, unimpeded flow of flammable gases or a reduction in ventilation can lead to explosions if an ignition source is also present.

The easiest and simplest way to understand small and safe explosions is by looking at a gas lighter. When the nozzle of the lighter is opened, it releases a small amount of flammable gas. This gas mixes with the surrounding air, the spark from the flint ignites the mixture, and a weak sound is heard - the burning. Some distance away from the nozzle the proportion of the flammable gas is already so low that the explosion and the flame are restricted to the immediate vicinity of the nozzle. In other words, the design of the gas lighter has ensured that it is safe to use.

The effect of an explosion in enclosed spaces and under non-atmospheric conditions - e. g. under increased pressure - is often more powerful. Just think of the useful application of explosions in vehicle engines.

To attain effective explosion protection against non-controlled, unintended explosions linked to disastrous consequences, it is necessary to remove one of the three factors.

BARTEC products prevent ignition sources or coming together of such sources with potentially explosive atmospheres. They effectively prevent explosions because the other two factors - the oxygen in the air and often the flammable substance - cannot be reliably and permanently ruled out in workplaces.



Figure 3

Primary explosion protection

Primary explosion protection aims at substituting something else for the flammable substances or the atmospheric oxygen or reducing their quantities to the point where there is no danger of an explosive mixture forming.

Increased air circulation, air flushing through ventilation can be achieved by structural measures; e. g. the open layout of filling stations where the potentially explosive atmosphere is very small.

Replacing the atmospheric oxygen is not an option for areas where people work. For this reason the measures available for such locations are limited to:

- avoidance or restriction of flammable substances which are capable of forming an explosive atmosphere
- avoidance or restriction of release of the flammable substances and therefore formation of explosive mixtures, both inside and around fittings,
 - e. g. by
 - limiting their concentration
 - using enclosures filled with an inert substance
 - natural or artificial ventilation
 - concentration monitoring by means of a gas detection system, which will give an alarm/or switch off the system

Secondary explosion protection

If, despite primary explosion protection measures, it is possible for a hazardous, potentially explosive atmosphere to form (to a degree that requires measures to protect employees against explosion hazards), the ignition of this hazardous, potentially explosive atmosphere must be effectively prevented. All possible sources of ignition are evaluated, and the appropriate protective measures applied.

Effective sources of ignition on equipment and installations can, for example, be prevented using types of protection corresponding to the necessary level of protection. The classification of potentially explosive areas into zones (The frequency and duration of the occurrence of a hazardous explosive atmosphere and the local environmental conditions) forms the basis for defining the level of protection for equipment. It is furthermore necessary to know the key explosion-related figures for the flammable materials (temperature classes, dust ignition temperatures, explosion sub-groups etc.) as well as the local ambient conditions.

The explosion characteristics help the owner / managing operator to specify the risk in the area precisely and help the operating equipment manufacturer to select a suitable solution for the operating equipment and finally they help the installation engineer to select and assign the suitable devices. Ultimately, this data is found in the device labelling.

The procedures for applying secondary explosion protection measures will be described in greater detail in the following chapter.

Tertiary explosion protection

If the primary and secondary explosion protection measures are not enough, additional protective measures must be taken. The purpose of these is to limit the impact of an explosion and/or to reduce it to a non-hazardous level. The most common measures to limit the hazardous effects of explosion are as follows:

- Explosion-resistant design: containers, apparatus, pipelines are built to be pressure shock resistant in order to withstand an explosion inside.
- Explosion relief: bursting discs or explosion flaps are deployed which open in a safe direction if an explosion occurs and make sure that the plant is not subjected to strain over and above its explosion resistance.
- Explosion suppression and preventing propagation of the explosion: Explosion suppression systems prevent attainment of the maximum explosion pressure by rapidly injecting extinguishing agents into containers and plant. Explosion decoupling restricts possible explosions to individual parts of the plant.

SEKUNDARY EXPLOSION PROTECTION

Protection principles are defined to exclude equipment and components as ignition sources.

Relevance and advantage of the area classification in workplaces

The practice has been established of dividing potentially explosive atmospheres into zones. This classification takes the different dangers from explosive atmospheres into account and allows explosion protection measures to be taken which reflect the situation both from the point of view of safety engineering and of economic efficiency. For the European community, the zone definitions are uniformly provided in Directive 1999/92/EC. It must be applied with technical understanding of the specific situation.

Potentially explosive atmospheres are classified into zones according to the frequency and duration of the occurrence of the explosive atmosphere.

The representations in figures 4, 5, 6 and 7 are intended as suggestions. In a specific case, a lot of details and influencing factors must be taken into account for zone classification.

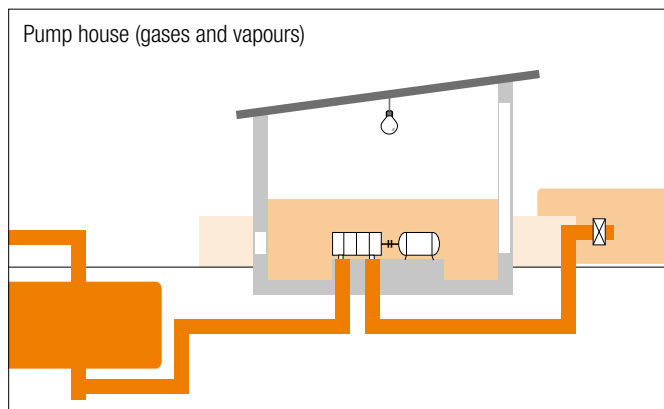

Figure 4

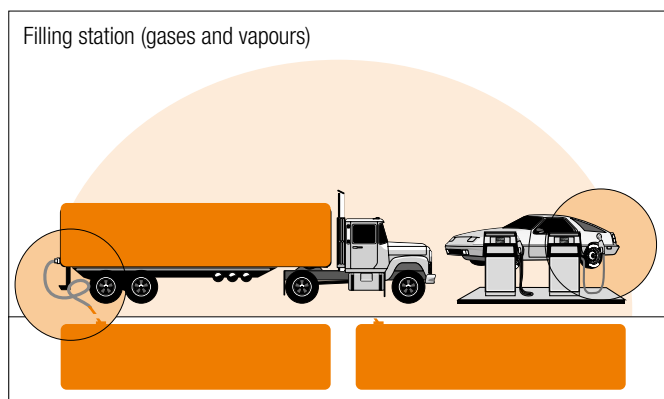

Figure 5

Classification of hazardous areas

Gases, vapours

Zone 0

place in which an explosive atmosphere consisting of a mixture with air of flammable substances in the form of gas, vapour or mist is present continuously or for long periods or frequently

Zone 1

place in which an explosive atmosphere consisting of a mixture with air of flammable substances in the form of gas, vapour or mist is likely to occur in normal operation occasionally

Zone 2

place in which an explosive atmosphere consisting of a mixture with air of flammable substances in the form of gas, vapour or mist is not likely to occur in normal operation but, if it does occur, will persist for a short period only

Dusts

Zone 20

place in which an explosive atmosphere in the form of a cloud of combustible dust in air is present continuously, or for long periods or frequently

Zone 21

area in which an explosive atmosphere in the form of a cloud of combustible dust in air is likely to occur, occasionally, in normal operation

Zone 22

area in which an explosive atmosphere in the form of a cloud of combustible dust in air is not likely to occur in normal operation but, if it does occur, will persist for a short period only

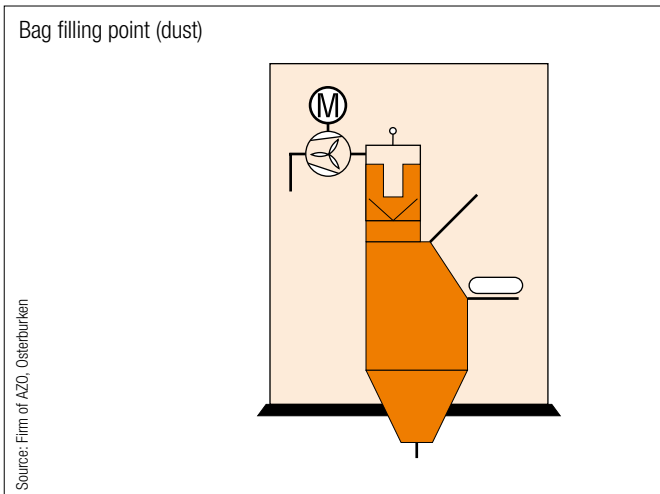

Figure 6

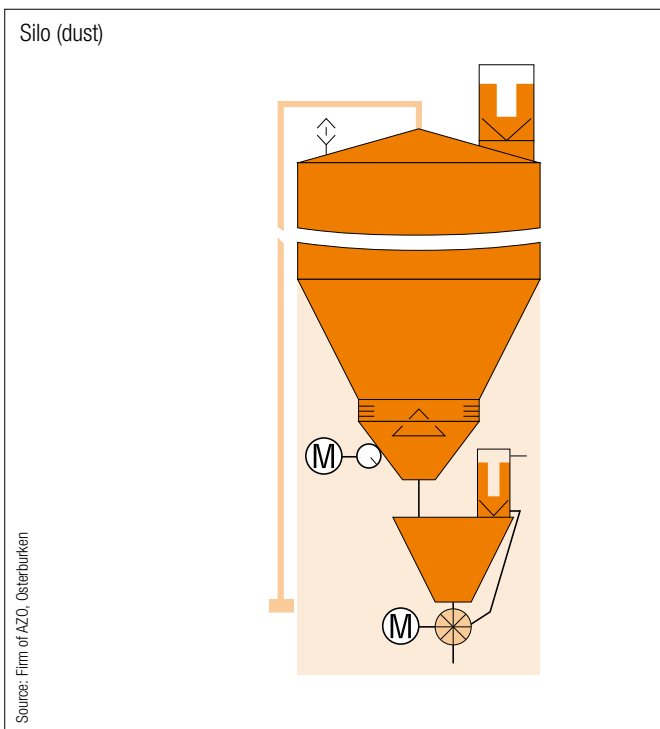

Figure 7

Caption

- Zone 0, Zone 20
- Zone 1, Zone 21
- Zone 2, Zone 22

IEC 60079-10-1 assumes an approximately similar classification for gases and vapours which will also apply to future facilities constructed in accordance with the US standard NEC 505. IEC 60079-10-2 provides support for the zone classification with dusts.

Potentially explosive atmospheres are classified depending on the frequency and duration of the explosive atmosphere. This classification provides the scope of the measures to be taken according to Annex II section A in the Directive 1999/92/EC in conjunction with Annex I of the Directive 2014/34/EU.

In places of work the potentially explosive atmospheres are normally classified at most as Zone 1 and 2 and or 21 and 22. Zone 0 and 20 are restricted to very small inaccessible areas in work places or are usually restricted to the inside of technical equipment.

Notes:

1. Layers, deposits and heaps of combustible must be considered as any other source which can form an explosive atmosphere.
2. 'Normal operation' means the situation when installations are used within their design parameters.
3. The definitions for explosive atmospheres comply with the EC directives and EN standards:

Explosive atmosphere:

this is a mixture of air and flammable substances in the form of gases, vapours, mists or dusts under atmospheric conditions in which, after ignition has occurred, combustion spreads to the entire unburned mixture.

Hazardous explosive atmosphere:

this is an explosive atmosphere that causes damage on explosion, and which necessitates the introduction of measures to protect employees from explosion hazards.

Organisational measures

The requisite preconditions for the safe operation of electrical equipment in potentially explosive atmospheres are created in a joint effort by the manufacturers of explosion protected equipment and the constructors and operators of industrial plants. It is important that the operator of such plants should ensure that their personnel know how the danger of explosions is likely to arise and the measures that are to be taken to prevent it.

The employees should be regularly trained on the contents of the explosion protection document in accordance with the Directive 1999/92/EC (occupational safety regulations) and informed by means of written corporate regulations which should be regularly updated.

Explosion parameters

In order to allow a combination of measures for explosion protection, which is optimised with respect to the chemical-physical properties of the flammable gases, vapours or dusts, to be made, and therefore a standardisation of the types of protection to be possible for the manufacturer, a system of explosion parameters has been created. These are determined using an application-orientated test method.

Before flammable substances can react with the atmospheric oxygen in an explosion, energy must be provided.

This energy may, for example, be exchanged on a surface. A heated surface increases the energy content of the explosive mixture in contact with it. If the surface temperature is sufficiently high, this increased energy content can lead to the explosive reaction. However, the energy may also be supplied through a spark or a hot gas jet flowing out of a gap into the explosive mixture. Both types lead to different explosion parameters being defined.

Ignition temperature

Gases/vapours temperature class

Many factors such as size, shape, type and surface quality have an influence on the ignition temperature. IEC, CENELEC and other standardisation committees have agreed on a method for gases and vapours defined in EN IEC 60079-20-1 „Method of test ignition temperature“. This method is defined in such a way, that a value very close to the lowest practically possible, is determined.

By means of this method, gases and vapours are divided into temperature classes. According to these temperature classes, the surface temperatures in explosion protected equipment and other technological objects is designed in such a way that ignition by the surface is not possible. In the standard, permissible excess values and necessary safety margins below these standard values are defined in detail.

Temperature classes	Ignition temperature range of the mixture	Permissible surface temperature of the electrical equipment
T1	> 450 °C	450 °C
T2	> 300 °C ... ≤ 450 °C	300 °C
T3	> 200 °C ... ≤ 300 °C	200 °C
T4	> 135 °C ... ≤ 200 °C	135 °C
T5	> 100 °C ... ≤ 135 °C	100 °C
T6	> 85 °C ... ≤ 100 °C	85 °C

Table 3

Ignition temperature from dusts (layer and cloud)

For different types of dust, the method for determining the ignition temperature has also been unified and coded in document EN ISO/IEC 80079-20-2. Please note that dust in its deposited form (layer) has a different ignition temperature than in its stirred form (cloud).

The permissible surface temperature for those parts of the systems, equipment and components accessible to the dust is determined by subtracting 75 K ($T_{perm L} = T_{min L} - 75 K$) from the value determined for the dust layer and by multiplying by 2/3 ($T_{perm C} = 2/3 T_{min C}$) the value determined for the dust cloud.

The smaller of the 2 values determined in this way corresponds to the lowest permissible surface temperature of the equipment ($T_{perm L} \geq T_{perm} \leq T_{perm C}$). The surface is the area accessible to the dust, temperature classes are not defined for dust, so that a concrete type of dust must always be assumed. The parameters are made available in comprehensive tables, laboratories determine the values on request, and a small, non-official overview is contained in the following table (page 13).

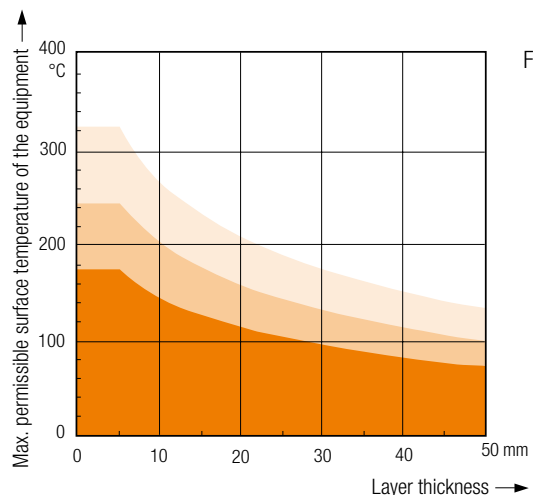

Figure 8

Smouldering temperature where layer thickness is 5 mm

- $400\text{ °C} \leq T_{5\text{ mm}}$
- $320\text{ °C} \leq T_{5\text{ mm}} < 400\text{ °C}$
- $250\text{ °C} \leq T_{5\text{ mm}} < 320\text{ °C}$

Layers of dust exceeding 5 mm

If deposits of dust with thicknesses of more than 5 mm can accumulate on devices, the maximum permissible surface temperature must be reduced accordingly. The diagram from the installation standard (EN IEC 60079-14) can be used as an aid here (Figure 8).

Accordingly, where dust has an ignition temperature (smouldering temperature where the layer is 5 mm thick) of more than 250 °C, the maximum surface temperature must be adjusted to suit the characteristics. Where types of dust have an ignition temperature (smouldering temperature for 5 mm layer thickness) less than 250 °C or where there is a doubt about the characteristic curve, the dependence must be determined in laboratory tests.

Examples of the ignition temperatures of different types of dust

Designation of the solid material	A values ignition temperature EN ISO/IEC 80079-20-2 deposit (°C)	B values ignition temperature EN ISO/IEC 80079-20-2 cloud (°C)	Permissible limiting temperature lowest value of the calculation (A-75K) and 2/3*B									
			450... > 300	300... > 280	280... > 260	260... > 230	230... > 215	215... > 200	200... > 180	180... > 165	165... > 160	160... > 135
Dust from natural materials (examples)												
Cotton	350	560			275							
Brown coal	225	380										150
Cellulose	370	500		295								
Cereals	290	420						215				
Sawdust (wood)	300	400					225					
Cocoa	460	580	385									
Cork	300	470					225					
Fodder concentrate	295	525					220					
Milk powder	340	440			265							
Paper	300	540					225					
Soya	245	500								170		
Starch	290	440						215				
Hard coal	245	590								170		
Tobacco	300	450					225					
Tea	300	510					225					
Wheat flour	450	480	320									
Dust of chemical technical products (examples)												
Cellulose ether	275	330								200		
Isosorbide dinitrate	240	220										146
Unvulcanised rubber	220	460										145
Petroleum coke	280	690						205				
Polyvinyl acetate	340	500			265							
Polyvinyl chloride	380	530	305									
Soot	385	620	310									
Laminated plastic	330	510				255						
Sulphur	280	280							186			
Metal dusts (examples)												
Aluminium	280	530						205				
Bronze	260	390							185			
Iron	300	310						206				
Magnesium	410	610	335									
Manganese	285	330						210				

Table 1

Explosion sub-group

Minimum ignition current ratio (MIC), Maximum experimental safe gap (MESG) - GASES/VAPOURS

Ignition on a hot surface occurs in a relatively large „macroscopic“ part of the mixture. In contrast, the ignition from a spark spreads in a relatively small „microscopic“ part of the volume. The discharge from a capacitor or the interruption of a predefined resistive/inductive electric circuit can be used for classifying gases and vapours or dusts according to their ease of ignition in the microscopic part of the mixture volume.

For the assessment of the ignition of gases and vapours in a circuit using a equipment defined EN IEC 60079-11, a comparative value with methane as reference in a standardised circuit is used. This comparative value is the minimum ignition current ratio, MIC. It is the means used for classifying gases and vapours within explosion group II in the subgroups IIA, IIB and IIC.

An analogous grading is done when the ignitability of a hot gas jet escaping from a gap is used for the classification. In EN IEC 60079-20-1 „Method of test for ascertainment of the experimental safe gap“, a test apparatus is agreed in which a spherical gas volume of 20 cm³ is formed by two hemispheres. These have a 25 mm wide flange. This ball-shaped object is placed into a larger vessel and both spaces are filled with the mixture for which the safe gap is to be determined. The gap between the 25 mm wide flanges for which ten ignitions inside the ball volume just fail to ignite the mixture in the outer vessel is a value specific to the mixture and is called the maximum experimental safe gap, MESG.

The processes involved in the prevention or spread of the explosion in the gap are very complex. Classifying the gases and vapours by the safe gap results approximately - with a small overlap - in the same classification as that obtained with the minimum ignition current ratio. IEC/TR 60079-20-1 provides an overview of the classification using the two measuring methods MESG and MIC.

The safe gap value is of considerable importance for designs of protection type „Flameproof enclosure“; the value for the minimum ignition current ratio is important for those of protection type „Intrinsic safety“. For these two types of protection, the subgroups IIA, IIB and IIC for gases and vapours are relevant. The information on gases and vapours can also be applied approximately to mists.

For the assessment of conditions concerning electrostatic discharge, the minimum ignition energy of gases and vapours from the assignment to sub-group IIA, IIB or IIC can be assumed:

IIA approx. 300 µWs
IIB approx. 150 µWs
IIC < 50 µWs

Conductivity of the dust

From the point of view of electrical engineering, it is not possible to classify dust as precisely as the chemically defined gases and vapours. For that reason, it is considered sufficient to divide the dust according to type and conductivity. EN ISO IEC 80079-20-2 contains the test method to determine the specific electrical resistance of dust. Dust is divided into 3 sub-groups depending on this level of resistance:

- IIIA** combustible flyings
- IIB** non-conductive combustible dust,
specific electrical resistance $> 10^3 \Omega$
- IIC** conductive combustible dust,
specific electrical resistance $\leq 10^3 \Omega$

The **minimum ignition energy**, a parameter similar to the minimum ignition current, is determined in accordance with IEC 61241-2-3 for flammable dusts

The following table shows examples of the assignment of gases and vapours to the respective temperature classes and explosion sub-groups

Gases and vapours			Assignment of the gases and vapours acc. to Ignition temperature	Temperature class
Acetone Ammonia Benzene - pure Acetic acid Ethane Ethyl acetate Ethyl chloride Carbon monoxide Methane Methanol Methylene chloride Naphthalene Phenol Propane Toluene	Town gas	Hydrogen	> 450 °C	T1
Ethyl alcohol i amyl acetate n butane n butyl alcohol Cyclohexane Acetic anhydride	Ethylene Ethylene oxide	Ethine (acetylene)	> 300 °C to ≤ 450 °C	T2
Petroleum spirit - gen. Diesel fuel Jet propulsion fuel Heating fuel DIN 51603 n hexane	Ethylene glycol Hydrogen sulphide		> 200 °C to ≤ 300 °C	T3
Acetaldehyde	Ethyl ether		> 135 °C to ≤ 200 °C	T4
			> 100 °C to ≤ 135 °C	T5
		Carbon bisulphide	> 85 °C to ≤ 100 °C	T6

Assignment of the gases and vapours acc. to

Maximum experimental safe gap (MESG)

> 0.9 mm	0.5 mm < MESG < 0.9 mm	< 0.5 mm
----------	------------------------	----------

Minimum ignition current ratio (MIC)

> 0.8 mm	0.45 mm < MIC < 0.8 mm	< 0.45 mm
----------	------------------------	-----------

Explosion subgroups (Marking)

IIA	IIB	IIC
-----	-----	-----

Table 2

Protection principles

Protection principles are defined to exclude equipment and components as ignition sources.

The protection principles can be equally applied to electrical and non-electrical devices and for gases and for dusts. The principles allow for a design in various safety categories in accordance with the Directive 2014/34/EU or the Equipment Protection Level (EPL) according with EN IEC 60079-0 ff:

Equipment category 1	with very high level of protection and thus a very high degree of safety
Equipment category 2	with high level of protection and therefore a high degree of safety
Equipment category 3	with normal level of protection and therefore a conventional degree of safety
Equipment Protection Level a	with very high level of protection and thus a very high degree of safety
Equipment Protection Level b	with high level of protection and therefore a high degree of safety
Equipment Protection Level c	with normal level of protection and therefore a conventional degree of safety

Ignition sources which are caused by sparks from friction or impact or from electro-static charging have to be prevented in explosion protected equipment by selecting appropriate materials and by constructive measures, and this must be verified and confirmed by the appropriate tests. Four protection principles can prevent equipment from becoming an ignition source. The types of protection listed as examples in the overview are discussed in a different chapter.

An important precondition for all the protection principles is that parts which are in unhindered contact with the explosive atmosphere must not be able to reach non-permitted temperatures with respect to the ignition temperature of substances present in the site of installation. This means that the ignition temperature is relevant for all protection principles.

Explosive mixtures can enter the equipment in which an ignition source may be located, enter and be ignited. The transmission of running inside explosion on the surrounding space is excluded.

Examples of types of protection:

Flameproof enclosures (Ex d) – electrical and non-electrical devices

Powder filling (Ex q) – electrical devices

The operating equipment has an enclosure which prevents the penetration of the explosive mixture and/or contact with the function-related possible internal sources of ignition.

Examples of types of protection:

Pressurized enclosures (Ex p) - electrical and non-electrical devices

Protection by enclosures (Ex t) - electrical devices

Oil immersion (Ex o) - electrical devices

Liquid immersion (Ex h (before k)) - non-electrical devices

Encapsulation (Ex m) - electrical devices

Explosive mixtures can penetrate the enclosure of the operating equipment but must not be ignited. Sparks and temperatures capable of causing ignitions must be prevented.

Examples of types of protection:

Non-sparking devices (Ex e) - electrical devices

Protection by constructional safety (Ex h (before c))
- non-electrical devices

Explosive mixtures can penetrate the operating equipment's enclosure but must not be ignited. The occurrence of sparks and increased temperatures must be limited.

Examples of types of protection:

Intrinsically safe (Ex i) - electrical devices

Protection by control of ignition source (Ex h (before b))
- non-electrical devices

Design regulations and prevention of effective sources of ignition in electrical devices

Hazards arising from the handling of flammable gases, vapours and dusts are caused by uniform chemical and physical processes. For this reason, the protection against these hazards must be carried out in a uniform manner.

Nearly universal uniform requirements have now been formulated by the International Electrotechnical Commission IEC, by the European Standardisation Committees CENELEC and CEN.

Manufacturers and operators are required to adhere to these, and where there are increased protection requirements, they are monitored by notified bodies and the authorities.

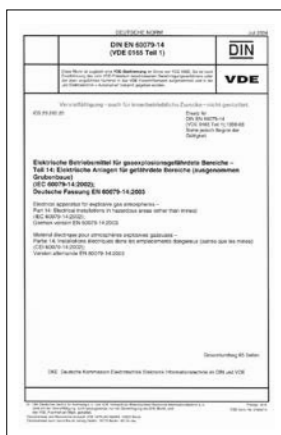

Product idea

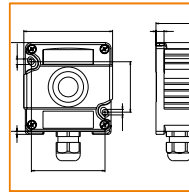

Designed in compliance with EN IEC 60079-0 ff design regulations (gases, vapours and dust)

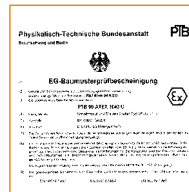

Testing and certification by a notified body EC-type examination certification or by a certified body IECEx Certificate of Conformity



Manufacturer's recognised quality assurance system in compliance with Directive 2014/34/EU or IECEx System (QAR) and EN ISO 80079-34



Manufacturing - routine tests



Selection and installation in compliance with the EN IEC 60079-14 erection regulations



Commissioning in compliance with Directive 1999/92/EG (EU) or EN IEC 60079-14



Maintenance and repair in compliance with Directive 1999/92/EC, national requirements EN IEC 60079-17 EN IEC 60079-19

Figure 9

Standards for explosion protection

An overview of the regulations for the determination of the parameters, the classification of zones, the design regulations for systems, devices and components as well as installation and operation in the area where explosive gases, vapours and dusts are present, is shown in the table below which corresponds to the version as of April 2010 and may be subject to subsequent changes.

Title/contents	Registration No. IEC	CEN/CENELEC	DIN
Explosion protection principles and key figures			
Principles			
Explosive atmospheres - Explosion prevention and protection - Part 1: Basic concepts and methodology	-	EN 1127-1	DIN EN 1127-1
Explosive atmospheres - Explosion prevention and protection - Part 2: Basic concepts and methodology for mining	-	EN 1127-2	DIN EN 1127-2
Potentially explosive atmospheres - Terms and definitions for equipment and protective systems intended for use in potentially explosive atmospheres	-	EN 13237	DIN EN 13237
Explosive atmospheres - Part 32-2: Electrostatic hazards - Tests	IEC 60079-32-2	EN 60079-32-2	DIN EN 60079-32-2
Key figures for flammable gases, vapours and dusts			
Determination of maximum explosion pressure and the maximum rate of pressure rise of gases and vapours		EN 13673-1	DIN EN 15967
Explosive atmospheres - Part 20-1: Material characteristics for gas and vapour classification - Test methods and data	IEC 60079-20-1	EN 60079-20-1	DIN EN 60079-20-1
Testing of mineral oil hydrocarbons - Determination of ignition temperature	-	-	DIN 51794
Determination of the auto ignition temperature of gases and vapours	-	EN 14522	DIN 14522
Explosive atmospheres - Material characteristics - Combustible dusts test methods	ISO/IEC 80079-20-2	EN ISO 80079-20-2	DIN EN ISO 80079-20-2
Electrical apparatus for use in the presence of combustible dust. Part 2: Test methods - Section 1: Methods for determining minimum ignition temperatures of dust	IEC 61241-2-1	-	-
Electrical apparatus for use in the presence of combustible dust. Part 2-1: Test methods. Methods of determining minimum ignition temperatures	-	EN 50281-2-1	DIN EN 50281-2-1
Electrical apparatus for use in the presence of combustible dust. Part 2: Test methods - Section 2: Method for determining the electrical resistivity of dust in layers	IEC/TR 61241-2-2	EN 61241-2-2	DIN EN 61241-2-2
Electrical apparatus for use in the presence of combustible dust. Part 2: Test methods - Section 3: Method for determining minimum ignition energy of dust/air mixtures	IEC 61241-2-3	-	-



Title/contents	Registration No. IEC	CEN/CENELEC	DIN
Explosion protection on equipment/types of protection			
Types of protection of explosion protected electrical and non-electrical equipment – flammable gases, vapours and dusts			
Explosive atmosphere - Part 0: Equipment - General requirements	IEC 60079-0	EN 60079-0	DIN EN 60079-0
Non-electrical equipment for use in potentially explosive atmospheres - Part 1: Basic method and requirements	-	EN 13463-1	DIN EN 13463-1
Explosive atmospheres - Part 36: Non-electrical equipment for use in explosive atmospheres - Basic method and requirements	EN ISO 80079-36	EN ISO 80079-36	DIN EN ISO 80079-36
Types of protection of explosion protected electrical equipment – flammable gases, vapours and dusts			
Explosive atmospheres - Part 1: Equipment protection by flameproof enclosure "d"	IEC 60079-1	EN 60079-1	DIN EN 60079-1
Explosive atmospheres - Part 2: Equipment protection by pressurised enclosure "p"	IEC 60079-2	EN 60079-2	DIN EN 60079-2
Explosive atmospheres - Part 5: Equipment protection by powder filling "q"	IEC 60079-5	EN 60079-5	DIN EN 60079-5
Explosive atmospheres - Part 6: Equipment protection by liquid immersion "o"	IEC 60079-6	EN 60079-6	DIN EN 60079-6
Explosive atmospheres - Part 7: Equipment protection by increased safety "e"	IEC 60079-7	EN 60079-7	DIN EN 60079-7
Explosive atmospheres - Part 11: Equipment protection by intrinsic safety "i"	IEC 60079-11	EN 60079-11	DIN EN 60079-11
Explosive atmospheres - Part 13: Equipment protection by pressurised room "p"	IEC 60079-13	EN 60079-13	DIN EN 60079-13
Electrical apparatus for explosive gas atmospheres - Part 15: Construction, testing and marking for type "n" protected electrical equipment.	IEC 60079-15	EN 60079-15	DIN EN 60079-15
Electrical apparatus for explosive gas atmospheres - Part 16: Artificial ventilation for the protection of analyser houses	IEC/TR 60079-16	-	-
Explosive atmospheres - Part 18: Equipment protection by encapsulation "m"	IEC 60079-18	EN 60079-18	DIN EN 60079-18
Explosive atmospheres - Part 25: Intrinsically safe systems	IEC 60079-25	EN 60079-25	DIN EN 60079-25
Explosive atmospheres - Part 26: Equipment with equipment protection level (EPL) Ga	IEC 60079-26	EN 60079-26	DIN EN 60079-26
Explosive atmospheres - Part 27: Fieldbus intrinsically safe concept (FISCO)	IEC 60079-27	EN 60079-27	DIN EN 60079-27
Explosive atmospheres - Part 28: Protection of equipment and transmission systems using optical radiation	IEC 60079-28	EN 60079-28	DIN EN 60079-28
Explosive atmospheres - Part 29-1: Gas detectors - Performance requirements of detectors for flammable gases	IEC 60079-29-1	EN 60079-29-1	DIN EN 60079-29-1
Explosive atmospheres - Part 29-2: Gas detectors - Selection, installation, use and maintenance of detectors for flammable gases and oxygen	IEC 60079-29-2	EN 60079-29-2	DIN EN 60079-29-2



Title/contents	Registration No. IEC	CEN/CENELEC	DIN
Explosive atmospheres - Part 29-4: Gas detectors - Performance requirements of open path detectors for flammable gases: General information and test methods	IEC 60079-29-4	EN 60079-29-4	DIN EN 60079-29-4
Explosive atmospheres - Part 30-1: Electrical resistance trace heating - General information and test methods	IEC 60079-30-1	EN 60079-30-1	DIN EN 60079-30-1
Explosive atmospheres - Part 30-2: Electrical resistance trace heating - Application guide for design, installation and maintenance	IEC 60079-30-2	EN 60079-30-2	DIN EN 60079-30-2
Explosive atmospheres - Part 31: Equipment dust ignition protection by enclosure "t"	IEC 60079-31	EN 60079-31	DIN EN 60079-31
Explosive atmospheres - Part 33: Equipment protection by special protection "s"	IEC 60079-33	-	-
Caplights for use in mines susceptible to firedamp - Part 1: General requirements - Construction and testing in relation to the risk of explosion	IEC 60079-35-1	EN 60079-35-1	DIN EN 60079-35-1
Caplights for use in mines susceptible to firedamp – Part 2: Performance and other safety-related matters	IEC 60079-35-2	DIN EN 60079-35-2	DIN EN 60079-35-2
Types of protection of explosion protected non-electrical equipment – flammable gases, vapours and dusts			
Non-electrical equipment for use in potentially explosive atmospheres - Part 2: Protection by flow restricting enclosure 'fr'	-	EN 13463-2	DIN EN 13463-2
Non-electrical equipment for use in potentially explosive atmospheres - Part 3: Protection by flameproof enclosure 'd'	-	EN 13463-3	DIN EN 13463-3
Non-electrical equipment for use in potentially explosive atmospheres - Part 5: Protection by constructional safety 'c'	-	EN 13463-5	DIN EN 13463-5
Non-electrical equipment for use in potentially explosive atmospheres - Part 6: Protection by control of ignition source 'b'	-	EN 13463-6	DIN EN 13463-6
Non-electrical equipment for use in potentially explosive atmospheres - Part 8: Protection by liquid immersion 'k'	-	EN 13463-8	DIN EN 13463-8
Explosive atmospheres - Part 37: Non-electrical equipment for use in explosive atmospheres - Non electrical type of protection constructional safety "c", control of ignition source "b", liquid immersion "k"	ISO/IEC 80079-37	EN ISO 80079-37	DIN EN ISO 80079-37
Explosive atmospheres - Part 38: Equipment and components in explosive atmospheres in underground mines	ISO/IEC 80079-38	EN ISO/IEC 80079-38	DIN EN ISO/IEC 80079-38

Title/contents	Registration No. IEC	CEN/CENELEC	DIN
Manufacturing & quality management system			
Explosive atmospheres - Part 34: Application of quality systems for equipment manufacture	ISO/IEC 80079-34	EN 80079-34	DIN EN 80079-34
Explosion protection in installations			
Classification of endangered areas into gases, vapours and dusts			
Explosive atmospheres - Part 10-1: Classification of areas - Explosive gas atmospheres	IEC 60079-10-1	EN 60079-10-1	DIN EN 60079-10-1
Explosive atmospheres - Part 10-2: Classification of areas - Explosive dust atmospheres	IEC 60079-10-2	EN 60079-10-2	DIN EN 60079-10-2
Installation, maintenance and repair of electrical installations			
Explosive atmospheres - Part 14: Electrical installations design, selection and erection	IEC 60079-14	EN 60079-14	DIN EN 60079-14
Explosive atmospheres - Part 17: Electrical installations inspection and maintenance	IEC 60079-17	EN 60079-17	DIN EN 60079-17
Explosive atmospheres - Part 19: Equipment repair, overhaul and reclamation	IEC 60079-19	EN 60079-19	DIN EN 60079-19

Table 3

Note about how to use the table

The table is intended as an **overview of information** on the body of explosion protection standards. For specific work requiring the use of the standards and to procure the standards, ask the publishers or the standardisation committees for their updated status.

With the help of this table, the contents listed in the title/contents column can be correlated to the regional and national equivalents. The regional and national title does not need to correspond to the “world” title.

At BARTEC the design regulations are consistently applied for electrical equipment. Conformity is - after the completion of the development at BARTEC - checked by notified bodies, test laboratories of the IEC Ex-scheme as well as test laboratories of the European Community or by national test laboratories, and compliance is monitored and realised using a quality assurance system for every piece of equipment produced. During the routine test, safety-relevant requirements are checked according to the specifications and confirmed by means of a marking.

BARTEC also supports its customers with non-electrical equipment using the knowledge it has accumulated over decades of experience.

TYPES OF PROTECTION

It applies to all types of protection where parts that are in unhindered contact with the explosive atmosphere are not permitted to reach unacceptably high temperatures.

Taking into account both the environmental temperature and the heating effect, the temperature may attain maximum values which corresponds to the temperature class or the permissible surface temperature specified for flammable dusts in accordance with which the explosive atmosphere has been classified.

Historically, the types of protection were developed on the basis of four protection principles with a high level of safety (today's EPL b).

By classifying the potentially explosive areas into zones, an attempt is made to graduate the types of protection and assign different protection levels. This is done in the standardisation bodies. On the one hand, the known Ex n (Zone 2/22) types of protection are assigned to the EPL c protection level. On the other hand, the stringency of the requirements known up to now for EPL b (Zone 1/21) have to some extent been increased for EPL a (Zone 0/20).

General requirements

Principle

All generally applicable requirements for the operating equipment are summarised in the following standards

- EN IEC 60079-0 for electrical devices (gases, vapours and dust)
- EN IEC 13463-1ff for non-electrical equipment
- EN ISO 80079-36, -37 for non-electrical equipment (new)

The ignition protection standards can complement or nullify these requirements.

Uniform protection requirements concerning several types of protection such as protection against electrostatic charging, provision of a potential bond for metal enclosures, or mechanical strength against impact, are summarised in these standards under general engineering requirements. In this case, individual, more specific standards can demand either more stringent requirements or less stringent ones.

These requirements are based partially on those for electrical equipment for gases and vapours, deviations for dust and non-electrical equipment are contained in the individual basic standards. Categories 1 to 3 which the equipment has to fulfil can also include different general requirements.

The general temperature range for the application of explosion protected electrical equipment is defined as -20 °C to +40 °C. Permissible deviations extending or restricting the temperature range must be specified.

The parameters determined at approximately +20 °C in the laboratory for the subgroups IIA, IIB and IIC apply for a temperature range of ± 40 K - that is to say also from -20 °C to +60 °C.

These two temperature ranges take, on the one hand, the situation at the workplace into account and also, on the other, a certain heating up of the equipment during operation. The explosion pressure, permissible gap widths and permissible non-igniting currents change outside this temperature range. This has to be considered when using the equipment, and it can require different test conditions.

Types of protection to electrical equipment

Protection principles	Types of protection	Flammable material	Category 1 EPL a	Category 2 EPL b	Kategorie 3 EPL c
			Very high level of protection	High level of protection	Normal level of protection
All	General requirements EN IEC 60079-0	Gas/vapour (G) dust (D)	+	+	+
Protection principle ensures that an ignition source cannot arise.	Increased safety Ex e EN IEC 60079-7	Gas/vapour (G)	–	Ex eb	Ex ec
	Optical radiation interlocked with optical breakage EN IEC60079-28	Gas/vapour (G) dust (D)	–	Ex op sh	–
Protection principle prevents an ignition source becoming effective.	Intrinsic safety Ex i EN IEC 60079-11 EN IEC 60079-25 systems	Gas/vapour (G) dust (D)	Ex ia	Ex ib	Ex ic
	Inherently safe optical radiation EN IEC 60079-28	Gas/vapour (G) dust (D)	Ex op is	–	–
Protection principle prevents the potentially explosive atmosphere reaching the ignition source.	Encapsulation Ex m EN IEC 60079-18	Gas/vapour (G) dust (D)	Ex ma	Ex mb	Ex mc Ex n*
	Oil immersion Ex o EN IEC 60079-6	Gas/vapour (G)	–	Ex ob	Ex oc
	Pressurised enclosure Ex p EN IEC60079-2(G) / -4(D)	Gas/vapour (G) dust (D)	–	Ex pxb, pyb	Ex pzc
	Protection using enclosure Ex t EN IEC 60079-31	Dust (D)	Ex ta	Ex tb	Ex tc
	Protected optical radiation EN IEC 60079-28	Gas/vapour (G) dust (D)	–	Ex op pr	–
Protection principle prevents propagation of flames using an enclosure.	Flameproof enclosure Ex d EN IEC 60079-1	Gas/vapour (G)	Ex da	Ex db	Ex dc Ex n*
	Powder filling Ex q EN IEC 60079-5	Gas/vapour (G)	–	Ex q	–

* Requirements for explosion-protected devices for Zone 2/22 are to some extent only treated as Ex n type of protection in the standard EN IEC 60079-15.

Application in hazardous area

Zone 0/20	Zone 1/21	Zone 2/22
Zone 1/21	Zone 2/22	
Zone 2/22		

Table 4

Types of protection to non-electrical equipment

Protection principles	Types of protection	Flammable material	Category 1 EPL a Very high level of protection	Category 2 EPL b High level of protection	Category 3 EPL c Normal level of protection
All	General requirements EN 13463-1 EN ISO 80079-36 ¹⁾ /EN IEC 60079-0 ²⁾	Gas/vapour (G) dust (D)	+	+	+
Protection principle ensures that an ignition source cannot arise.	Constructional safety EN 13463-5 EN ISO 80079-37 ¹⁾	Gas/vapour (G) dust (D)	c Ex h	c Ex h	c Ex h
Protection principle prevents an ignition source becoming effective.	Control of ignition source EN 13463-6 EN ISO 80079-37 ¹⁾	Gas/vapour (G) dust (D)	b Ex h	b Ex h	b Ex h
Protection principle prevents the potentially explosive atmosphere reaching the ignition source.	Liquid immersion EN 13463-8 EN ISO 80079-37 ¹⁾	Gas/vapour (G) dust (D)	k Ex h	k Ex h	k Ex h
	Pressurised enclosure EN 13463-7 EN IEC 60079-2 ²⁾	Gas/vapour (G) dust (D)	– –	p Ex pxb, pyb	– Ex pzc
	Flow restricting enclosure EN 13463-2	Gas/vapour (G)	–	–	fr
	Protection by enclosures EN IEC 60079-31 ²⁾	Dust (D)	Ex ta	Ex tb	Ex tc
	Flameproof enclosure EN 13463-3 EN IEC 60079-1 ²⁾	Gas/vapour (G)	– Ex da	d Ex db	– Ex dc

¹⁾ The EN ISO 80079-36 and -37 standards form in addition to the EN IEC 60079-0 ff series of standards a holistic set of technical standards for the development, testing and certification of explosion-proof devices. The EN ISO standards will replace the EN 13463 -Parts 1, 5, 6 and 8 series of standards.

²⁾ The standard for electrical devices is also applied to non-electrical devices.

Application in hazardous area		
Zone 0/20	Zone 1/21	Zone 2/22
Zone 1/21	Zone 2/22	
Zone 2/22		

Table 5

Increased safety Ex eb EN IEC 60079-7

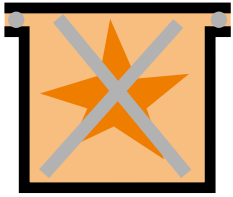
Principle

Additional measures provide a higher level of protection. This ensures reliable prevention of unacceptably high temperatures and sparks or electrical arcs, both on the internal and on the external parts of electrical equipment whose normal operation does not involve unacceptably high temperature sparks or arcing.

Important design parameters

- For uninsulated, live parts, special protective requirements apply.
- Air and creepage gaps are made wider than is generally the case in industry. Special conditions apply to the IP protection degree to be adhered to.
- For windings, their design, mechanical strength and insulation, higher requirements apply and the windings must be protected from increased temperatures.
- Minimum cross sections are stipulated for winding wire, the impregnation and reinforcement of coils and for thermal monitoring equipment.

Applications

- Installation material such as junction boxes, connection cabinets for heating systems, batteries, transformers, ballasts and cage motors.

Non-sparking device Ex ec EN IEC 60079-7 (previously Ex nA according to EN IEC 60079-15)

Principle

The construction ensures reliable prevention of unacceptably high temperatures and sparks or electrical arcs, both on the internal and on the external parts of electrical equipment whose normal operation does not involve unacceptably high temperature sparks or arcing.

Important design parameters

- For uninsulated, live parts, special protective requirements apply.
- Air and creepage gaps are specified.
- Special requirements must be fulfilled by certain types of equipment.

Applications

- Installation material such as junction boxes, connection cabinets, rotating electrical machines, special fuses, lamps, cells and batteries, transformers and low energy equipment.

Constructional safety c EN 13463-3 / **Ex h** EN ISO 80079-37

Principle

The systems, equipment and components are constructed in a way which ensures that they cannot turn into an ignition source under normal operation or in cases of faults.

Important design parameters

- Requirements placed upon the enclosure material are applicable as with the other types of protection
- The components must be selected in a way which ensures that their heating-up, e. g. by means of friction, is excluded.
- Furthermore, friction occurring under normal operation must not lead to electrostatic charging or friction sparks.
- The constructive requirements - derived from EN 1127-1 - must be verified with regard to possible ignition sources.

Applications

- Presently, only little experience is available as the standard is only applicable as draft yet.

Intrinsically safe Ex ia, ib, ic EN IEC 60079-11 (Ex ic previous version Ex nL according to EN IEC 60079-15)

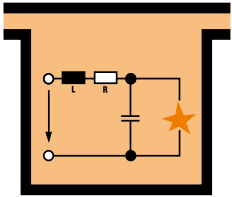

Principle

Intrinsically safe electrical equipment contains only circuits that meet the requirements of intrinsically safe circuits. Intrinsically safe circuits are circuits in which no spark or thermal effect occurring under the test conditions laid down in the standard can ignite the explosive atmosphere of subgroups IIA, IIB and IIC or of an air/dust mixture. The test conditions cover normal operation and certain fault conditions stipulated in the standard.

Important design parameters

- Use of certain components for electrical and electronic circuits.
- Lower permitted load on the components than in ordinary industrial applications with regard to
 - voltage related to electric strength
 - current related to heat
- Voltage and current, including a safety margin, are kept permanently so low that no impermissible temperatures can occur, and, in the event of open circuit or short-circuit, sparks and electric arcs possess so little energy that they are unable to ignite an explosive atmosphere.
- An impression of this protection type is provided by the fact that explosive atmospheres of subgroup IIA require only a few hundred μW and those of subgroup IIC only 10 μW for ignition.

Applications

- Measuring and monitoring instrumentation and control.
- Sensors working on the basis of physical, chemical or mechanical principles and at limited power.
- Actuators working on the basis of optical, acoustic and, to a certain extent, mechanical principles.

Protection by control of ignition sources b EN 13463-6 / **Ex h** EN ISO 80079-37



Principle

By monitoring ignition sources during normal operation, which are not present but might develop, such as parts heating up, reaction in critical situations is possible. Currently there is the idea to draft such a standard.

Important design parameters

- Use of sensor/actuator devices to monitor various physical-technical variables (temperature, pressure, flow, speed, vibrations etc.)
- To limit the risk of ignition, an evaluation is done of the quality (function) of the ignition sources at the mechanical equipment and the corresponding sensor/actuator monitoring equipment.
- The functional reliability (minimum quality) of the sensor/actuator monitoring equipment is specified in the form of ignition prevention levels (IPL).

Applications

- plain bearing, pump, agitator, vacuum pumps

Encapsulation Ex ma, mb, mc EN IEC 60079-18

Principle

Parts that could ignite an explosive atmosphere by means of sparks or heat are potted so as to prevent ignition of the explosive atmosphere. This is achieved by encapsulating the components in a compound resistant to physical - especially electrical, thermal and mechanical - and chemical influences.

Important design parameters

- Encapsulation:
 - Breakdown strength
 - Low water absorption
 - Resistance to various influences
 - Casting compound must be of the stipulated thickness all round
 - Cavities are only permitted to a limited extent
 - As a rule the casting compound is only penetrated by the cable entries
- The load on the components is limited or reduced
- Increased clearance between live parts

Applications

- Static coils in ballasts, solenoid valves or motors, relays and other control gear of limited power and complete PCBs with electronic circuits.

Non-incendive component Ex nC EN IEC 60079-15

Principle

Variant of the Ex n type of protection with contacts which close and open a circuit potentially able to trigger an explosion, where the contact mechanism or the enclosure into which the contacts are enclosed is designed in such a way that the ignition of a mixture of subgroup IIA, IIB or IIC in the surrounding environment is prevented as long as defined operating conditions apply.

Important design parameters

- Free internal volume $\leq 20 \text{ cm}^3$
- The encapsulation must permit a permanent temperature of $\geq 10 \text{ K}$ compared to the maximum operating temperature
- The combination of the parts is tightly sealed
- The design of the contacts will extinguish any incipient flame
- Limited to AC 254 V and 16 A
- L and C are part of the test
- Explosion subgroups IIA, IIB and IIC are to be treated differently

Applications

- Contact systems

Encapsulated device Ex nC EN IEC 60079-15

Principle

The equipment may include cavities which are fully enclosed similar to the encapsulation type of protection e. g. in a casting compound, so that ingress of the outer atmosphere is prevented.

Important design parameters

- It must be impossible to open the equipment during normal operation, internal free volume $\leq 100 \text{ cm}^3$
- External connections, terminals or cables must be available
- Cast seal must permit permanent operating temperature $\geq 10 \text{ K}$ compared to the maximum operating temperature
- It must not be possible for elastic seals to become mechanically damaged under normal operating conditions; they must maintain their sealing properties over the service life of the equipment

Applications

- Contact systems, static coils in ballasts, solenoid valves or motors and complete PCBs with electronic circuits.

Sealed device Ex nC EN IEC 60079-15

Principle

The equipment may include cavities, which are fully enclosed similar to the encapsulation type of protection so that ingress of the outer atmosphere is prevented.

Important design parameters

- It must be impossible to open the equipment during normal operation, internal free volume $\leq 100 \text{ cm}^3$
- External connections, terminals or cables must be available
- It must not be possible for elastic seals to become mechanically damaged under normal operating conditions; they must maintain their sealing properties over the service life of the equipment

Applications

- Contact systems, static coils in ballasts, solenoid valves or motors and complete PCBs with electronic circuits.

Hermetically sealed device Ex nC EN IEC 60079-15

Principle

The equipment may include cavities. It is constructed in such a way that the external atmosphere cannot enter.

Important design parameters

- Sealed by means of a melting process e. g.:
 - Soft solder
 - Hard solder
 - Welding
 - Fusing of glass and metal

Applications

- Spark generating equipment

¹⁾Oil/ ²⁾Liquid immersion Ex o EN IEC 60079-6¹⁾, k EN 13463-8²⁾/Ex h EN ISO 80079-37²⁾

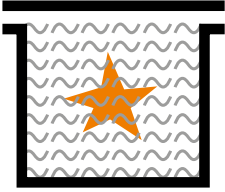

Principle

Parts which might ignite an explosive atmosphere are immersed in oil or other non-flammable, insulating liquid so that gases and vapours above the oil level and outside the enclosure cannot be ignited by electric arcs or sparks generated below the oil level, or by hot residual gases from the switching process or by hot surfaces - e. g. on a resistor.

Important design parameters

- Stipulated, insulating liquids, e. g. oil
Protection of the liquid from contamination and moisture.
- Non-electrical equipment
 - Liquids
 - Wetted surfaces
- Assurance and possibility of monitoring that the oil level is safe
 - When heated up or cooled
 - For identification of leaks
- Restricted to non-portable equipment.

Applications

- Large transformers, switchgear, starting resistors and complete starting controllers.
- Gear

Pressurized enclosures Ex px, Ex py EN IEC 60079-2 (for non-electrical devices) / **p** EN 13463-7

Principle

The ingress of the surrounding atmosphere into the enclosure of electrical equipment is prevented by maintaining an ignition shield gas (air, inert or a different suitable gas) inside it at a pressure above atmospheric pressure. The overpressure is maintained with or without constant flushing of the protective gas.

Important design parameters

- Strength of the enclosure; the surrounding, flushed enclosure must withstand 1.5 times the overpressure experienced during normal operation.
- Flush before commissioning the electrical equipment.
- Shut-down or alarm if the flushing gas flow or overpressure fails.

Applications

- Equipment where during normal operation sparks, electric arcs or hot surfaces are generated and complex industrial equipment (controls) which must be operated in a potentially explosive atmosphere protected by this type of protection.
- Large machines, slip ring or collector motors, switch cabinets and control cabinets and analytical apparatus.

Pressurized enclosures Ex pz EN IEC 60079-2

Principle

Use of a protective gas preventing ignition inside an enclosure to prevent the formation of an explosive atmosphere inside the enclosure by maintaining a pressure greater than the that in the surrounding atmosphere.

Important design parameters

- The important difference from the pressurized enclosure is the restriction to an enclosure where no internal sources are available and no flammable gases or vapours can be released.
- Strength of the enclosure.
- Flush before commissioning the electrical equipment.
- Shut-down or alarm if the flushing gas flow or overpressure fails.

Applications

- Equipment where during normal operation sparks, electric arcs or hot surfaces are generated and complex industrial equipment (controls) which must be operated in a potentially explosive atmosphere protected by this type of protection.
- Analytical apparatus without internal sources.

Restricted breathing Ex nR EN IEC 60079-15 (for non-electrical devices) / **fr** EN 13463-2

Principle

The enclosures are designed in such a way that the ingress of gases is restricted.

Important design parameters

- The powerloss in the enclosure may, if it contains sparking components, only lead to a temperature increase compared to the surrounding of ≤ 10 K.
- Equipment with these enclosures must allow monitoring of the vapour tightness and tightness after installation and maintenance.
- The allocation to the temperature class by the external surface temperature applies to all enclosures with and without sparking components.
- It must not be possible for elastic seals to become mechanically damaged under normal operating conditions; they must maintain their sealing properties over the service life of the equipment.
- Cast seals must permit a permanent operating temperature ≥ 10 K compared to the maximum operating temperature.

Applications

- Switchgear, measuring and monitoring instrumentation and information systems and equipment.
- Complex machinery, Large machines

Protection by enclosures Ex ta, tb, tc EN IEC 60079-31 (also applicable to non-electrical devices)

**Principle**

The enclosure is sealed so tight, that no combustible dust can enter. The surface temperature of the external enclosure is limited.

Important design parameters

- Minimum degree of protection in accordance with IEC/EN 60529 \geq IP 6X
- Consideration of dust accumulating on the surface and reduction of permissible surface temperature with dust layer \geq 5 mm are possible

Applications

- Various equipment where during normal operation sparks, electric arcs or hot surfaces occur and complex industrial designs (controllers) which by means of this type of protection can be utilised in the potentially explosive atmosphere.

Flameproof enclosures Ex da, db, dc EN IEC 60079-1 (for non-electrical devices) / **d** EN 13463-3

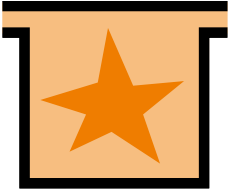
Principle

A type of protection in which the parts which could ignite an explosive atmosphere are located inside an enclosure which can withstand the pressure of an explosion of the explosive mixture inside, and prevents the transmission of the explosion to the explosive atmosphere surrounding the enclosure.

Technically unavoidable gaps are so long and narrow that hot gases jetting out will have lost their power to cause ignition by the time they reach the outside of the enclosure, or, alternatively, if the gaps are only required for the manufacturing process they might be sealed with adhesive.

Important design parameters

- Mechanical strength in accordance with a defined safety factor to withstand internal explosion pressure.
- As an orientation value, it may be assumed that inside the sphere approx. 0.8 MPa (8 bar) can be generated and that this sphere used as an Ex d enclosure must be able to withstand a pressure of 1.2 MPa (12 bar).
- Any gap between two parts of the enclosure must be kept so narrow and long that hot gas flowing out will not be able to ignite any explosive atmosphere which may be present in the potentially explosive atmosphere.
- The parameters for the gaps preventing the transmission of the ignition, width/length, are different for the explosion subgroups IIA, IIB and IIC. The most stringent requirements with regard to the gap parameters apply to enclosures in explosion subgroup IIC.

Applications

- Equipment where, during normal operation, sparks, electric arcs and/or hot surfaces are generated such as switchgear, slip rings, collectors, adjustable resistors, fuses or lamps, heating cartridges, friction brakes.

Enclosed-break device Ex nC EN IEC 60079-15

Principle

Switchgear as a variant of the Ex n type of protection, with contacts which close and open a circuit potentially able to trigger an explosion, where the enclosure will withstand an internal explosion of a mixture of subgroup IIA, IIB or IIC without being damaged and without transferring the explosion to the external mixture in the surrounding area.

Important design parameters

- Free internal volume $\leq 20 \text{ cm}^3$
- The encapsulation must permit a permanent temperature of $\geq 10 \text{ K}$ compared to the maximum operating temperature
- Limited to AC 690 V and 16 A

Applications

- Contact systems

Powder filling Ex q EN IEC 60079-5

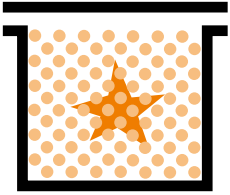
**Principle**

By filling the enclosure with a finely grained powder, an arc within the enclosure is unable, with correct use, to ignite the explosive atmosphere outside. There must be no risk of ignition by flames, nor by increased temperatures at the surface of the enclosure.

Important design parameters

- The filling such as sand, glass balls etc. has to fulfil specific requirements, as must the design of the enclosure. The filling must not be able to leave the enclosure, neither during normal operation, nor as the result of electric arcs or other processes inside the powder-filled enclosure.

Applications

- Capacitors, electronic assembly groups or transformers which are used in a potentially explosive atmosphere. Often components where sparks or hot surfaces occur but whose functioning is not affected by the finely grained filling.

Special protection Ex s EN IEC 60079-33

Devices which do not fully comply with a type of protection but assure comparable safety

MARKING

The marking on all equipment intended for use in potentially explosive atmospheres should provide all important information for safe operation. In addition, all information that is generally required for the same device in industrial design must be present.

Marking in accordance with Directive 2014/34/EU and EN standards

The requirements and assessments (incl. the marking) concerning electrical and non-electrical "equipment and protective systems intended for use in potentially explosive atmospheres" are uniformly defined in Directive 2014/34/EU. The marking of equipment and components is also specified in the standards for general technical requirements

(EN 60079-0 et seq. for electrical equipment or EN 13463-1 et seq., EN ISO 80079-36, -37 for non-electrical equipment).

Accordingly, the overall marking on an ATEX device is made up of the requirements under

Directive 2014/34/EU and the requirements of EN standards. Both sources define the same requirements in some areas, which leads to redundant information on the identification label. It is not possible to estimate whether and when this duplicated information will be synchronised.

The following should be recognizable from the marking:

1. The manufacturer that has placed the equipment on the market
2. The type designation by which the equipment can be identified
3. The application area below ground I or other areas II
4. The application area for gases and vapours - G -, dusts - D – or mines - M -
5. The categories that state whether the equipment may be used in certain zones
6. The type(s) of protection that the equipment satisfies
7. The explosion group and the explosion sub-group that the equipment is suitable for
8. The temperature class that the equipment complies with
9. The equipment protection level (EPL in accordance with EN 60079-0 and EN ISO 80079-36) and the gases and vapours (G) or dusts (D) application area that state whether the equipment may be used in certain zones
10. The special conditions, where necessary, that must be followed (X)
11. The type examination certificate with the test centre, the year of issue and the registration number of the certificate at the test centre

In accordance with Directive 2014/34/EU the future marking for all equipment will be as follows:

CE 0044 **II 2 G** - gas/vapour

CE 0044 **II 2 D** - dust

CE Conformity mark
0044 notified body who - if required - certified the QA system or the products

Marking in accordance with IEC standards

The international marking of the Ex devices and components is defined in IEC standards. The main points for marking and information are stipulated in the standards for the general technical requirement and the types of protection (IEC 60079-0 et seq.).

The following should be recognizable from the marking:

1. The manufacturer of the equipment
2. The type designation by which the equipment can be identified
3. The type(s) of protection that the equipment satisfies
4. The explosion group and the explosion sub-group that the equipment is suitable for
5. The temperature class that the equipment complies with
6. The equipment protection level (EPL in accordance with EN 60079-0 et seq.) and the gases and vapours (G) or dusts (D) application area that state whether the equipment may be used in certain zones
7. The special conditions, where necessary, that must be followed (X)
8. The type examination certificate with the test centre, the year of issue and the registration number of the certificate at the test centre

Application areas – equipment categories – equipment protection level

The following chart shows the designated areas of use of equipment and components according to equipment group and equipment category/equipment protection level.

Hazardous area

Conditions and subdivisions			Required marking on the usable equipment			
Flammable materials	Temporary behaviour of explosive atmosphere	Classification of hazardous areas	Equipment group as defined in directive 2014/34/EC	Equipment category as defined in directive 2014/34/EC	Equipment group as defined in EN IEC 60079-0 EN ISO 80079-36	Equipment protection level (EPL) as defined in EN IEC 60079-0 EN ISO 80079-36
Gases Vapours	Is present continuously or for long periods or frequently	Zone 0	II	1G	II	Ga
	Arises in normal operation occasionally	Zone 1	II	2G or 1G	II	Gb or Ga
	Is not likely to arise in normal operation, or if it does, will persist for a short time only	Zone 2	II	3G or 2G or 1G	II	Gc or Gb or Ga
Dusts	Is present in the form of a cloud continuously, or for long periods or frequently	Zone 20	II	1D	III	Da
	Occasionally develops into a cloud during normal operation	Zone 21	II	2D or 1D	III	Db or Da
	Is not likely to develop into a cloud during normal operation, or if it does, for a short time only	Zone 22	II	3D or 2D or 1D	III	Dc or Db or Da
Methane Carbon dust	Operation where there is a risk of explosion	-	II	M1	I	Ma
	Disconnection where there is a risk of explosion	-	I	M2 or M1	I	Mb or Ma

Table 6

Electrical equipment – gas/vapour and dust

Marking example in accordance with
RL 2014/34/EU, EN IEC 60079-0 ff

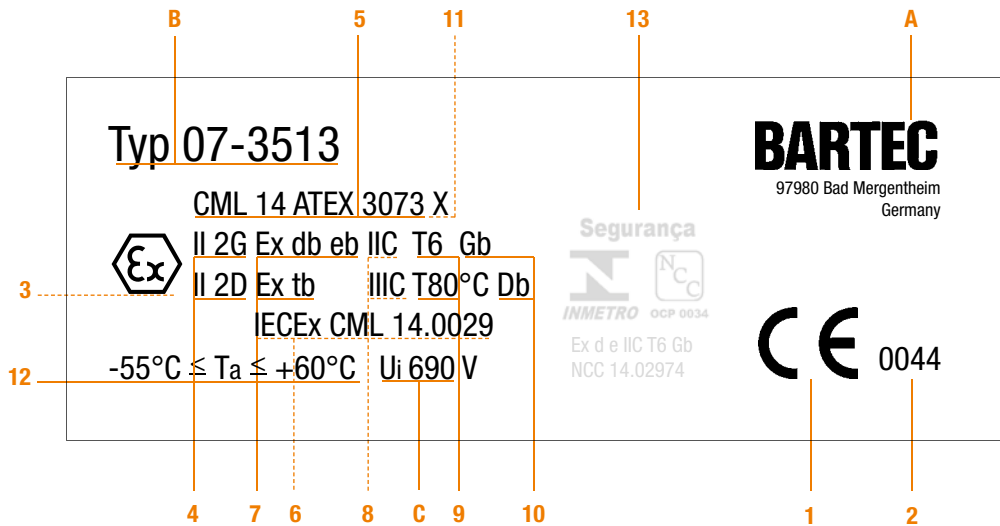

Figure 10

Information specific to explosion protection (marking)

ATEX directive and EN standards	IEC standards
1 Conformity mark (CE)	
2 Identification mark of the notified body which - where required - certified the QA system or examined the products (Category 1 and 2)	
3 Ex mark	
4 Equipment group II - other areas (non-mining) Equipment category 2 - gases/vapours G, suitable for Zones 1 and 2 - dusts D, suitable for Zones 21 and 22 (see Table 6)	
5 EU-type examination certification notified body's symbol, year notified body's registration number	6 CoC Certificate of Conformity notified body's symbol, year notified body's registration number
7 Explosion protection in compliance with EN IEC 60079-0 ff, Type of protection: flameproof enclosure and increased safety (gas) - Marked Ex d and Ex e, protection by enclosure (dust) - Marked Ex t	7 Explosion protection in compliance with EN IEC 60079-0 ff, Type of protection: flameproof enclosure and increased safety (gas) - Marked Ex d and Ex e, protection by enclosure (dust) - Marked Ex t
8 Explosion group IIC (above ground, group C), explosion group IIIC (conductible dusts)	
9 Temperature class T6 (gas), max. surface temperature 80°C (dust)	
10 Equipment protection level Gb (high protection level) (gas), equipment protection level Db (high protection level) (dust) (see Table 6)	
11 1. "X" observe special conditions: e. g. "the light module must be installed in a way that ensures its mechanical protection from impact energy in accordance with EN 60079-0". 2. "U" Ex Component which is not intended to be used alone. CE conformity is certified when installed into a complete operating equipment.	
12 Ambient temperature	
13 Marking in accordance with INMETRO (Example)	

General manufacturer information

- A** Manufacturer and address
- B** Type number of the product
- C** Other relevant information for industrial equipment

Non-electrical equipment – gas/vapour and dust

Marking example in accordance with Directive 2014/34/EU, EN and IEC standards (EN 13463-1ff/ISO 80079-36, -37)

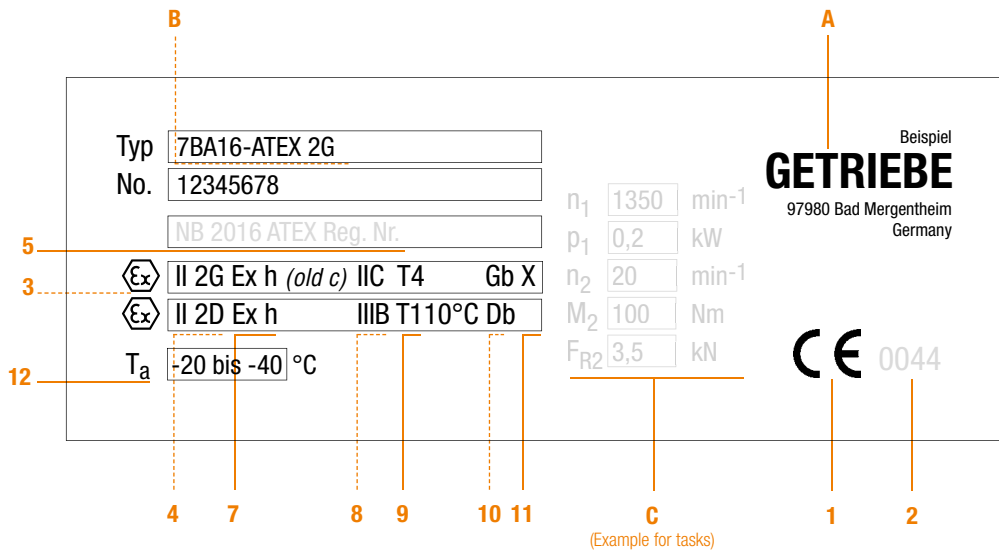

Figure 11

Information specific to explosion protection (marking)

ATEX directive and EN standards	ISO standards
<p>1 Conformity mark (CE)</p> <p>2 Identification mark of the notified body which - where required - certified the QA system or examined the products *</p>	
<p>3 Ex mark</p>	
<p>4 Equipment group II - other areas (non-mining) Equipment category 2 - Gases/vapours G, suitable for Zones 1 and 2 - Dusts D, suitable for Zones 21 and 22 (see Table 6)</p>	
<p>5 EU-type examination certification Notified body's symbol, year Notified body's registration number (only with Category 1)</p>	
<p>7 Explosion protection in compliance with EN ISO 80079-36, -37 standards type of protection: constructional safety - Marked Ex h <i>Explosion protection in compliance with EN 13463-1ff</i> <i>Type of protection: constructional safety</i> <i>- Marked c</i></p>	<p>7 Explosion protection in compliance with ISO 80079-36, -37 Standards type of protection: constructional safety - Marked Ex h</p>
<p>8 Explosion group IIC (above ground, group C)</p>	
<p>9 Temperature class T6 (gas)</p>	
<p>10 Equipment protection level Gb (high protection level) (gas) (see Table 6)</p>	
<p>11 1. "X" observe special conditions: e. g. The gearbox is to be installed only in certain position. 2. "U" Ex Component which is not intended to be used alone. CE conformity is certified when installed into a complete operating equipment. Components don't have any temperature class.</p>	
<p>12 Ambient temperature</p>	

General manufacturer information

- A** Manufacturer and address
- B** Type number of the product
- C** Other relevant information for industrial equipment

CONFORMITY

Ways of conformity and CE Marking to Directive RL 2014/34/EU

The conformity assessment procedures for “equipment and protective systems intended for use in potentially explosive atmospheres” are specified in Directive 2014/34/EU.

Depending on the equipment categories, the Directive stipulates which path the manufacturer must comply with up to preparation of the declaration of conformity. The following overview shows this path for the various conformity categories.

Conformity Assessment Procedure

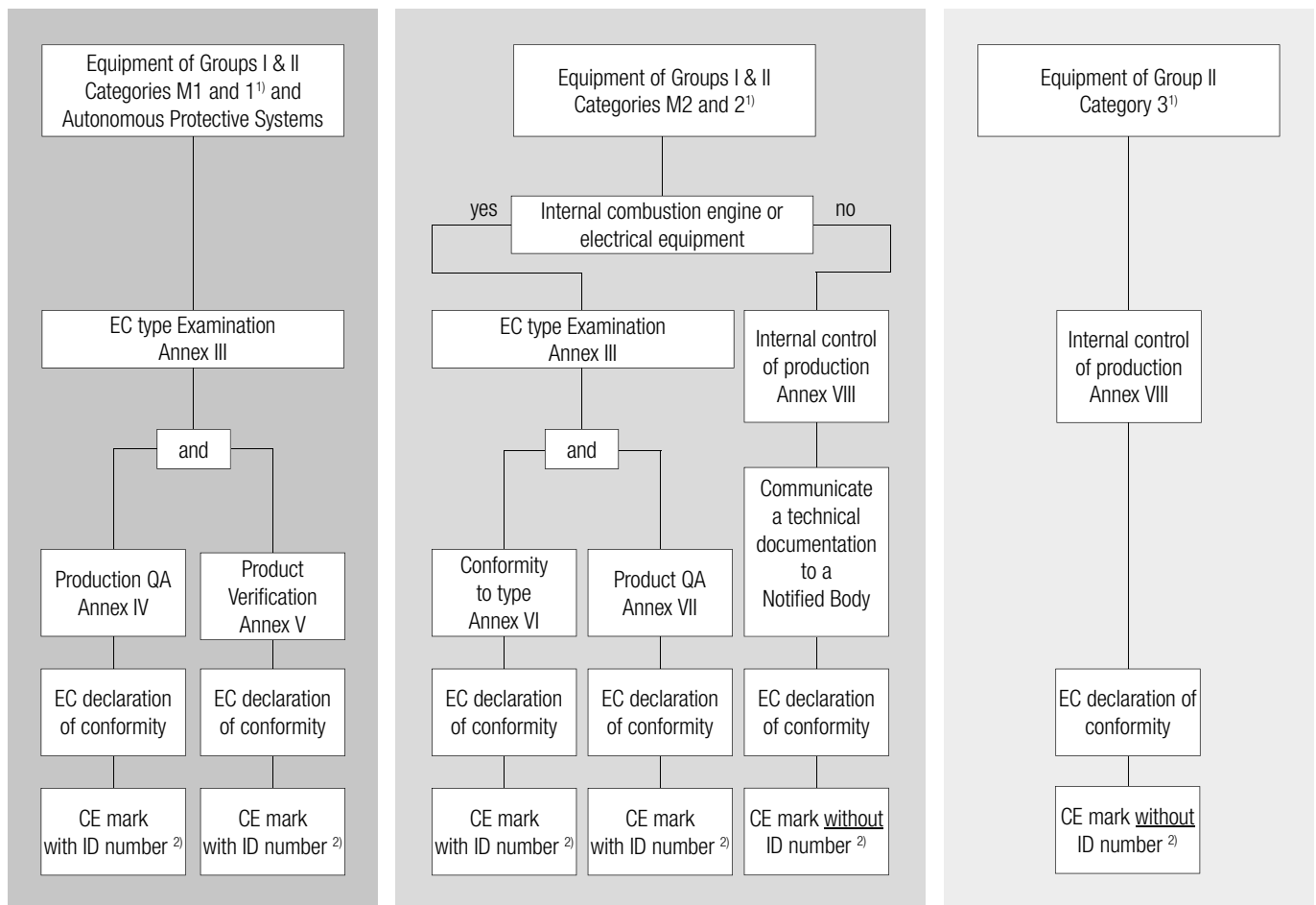

¹⁾ and their components and devices, if separately assessed.

²⁾ ID number of the notified body, which approved the QA system or verified the products.

Figure 12

Conformity in accordance with the IECEx system

The IECEx system stipulates the procedures for checking and certifying electrical equipment for use in Ex areas. All equipment must be tested by one certification centre, irrespective of the equipment protection level. The result of the test is an IECEx Certificate of Conformity. The manufacturer must simultaneously have his quality management system checked and audited by a certification body.

IECEx Certificate of Conformity (IECEx CoC)

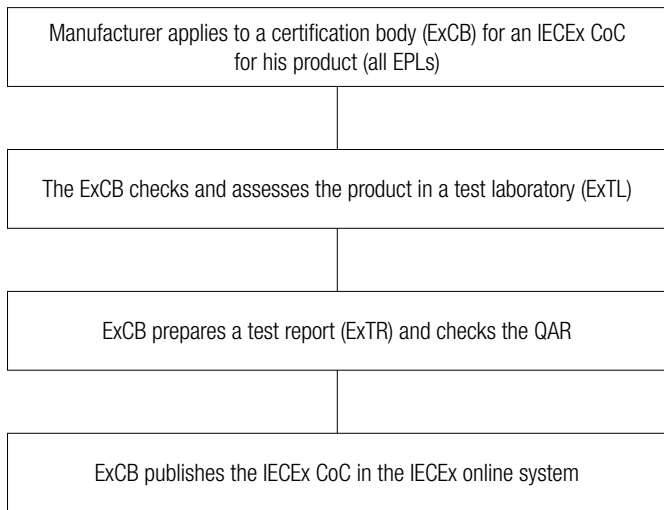

Recognised quality management system (QAR)

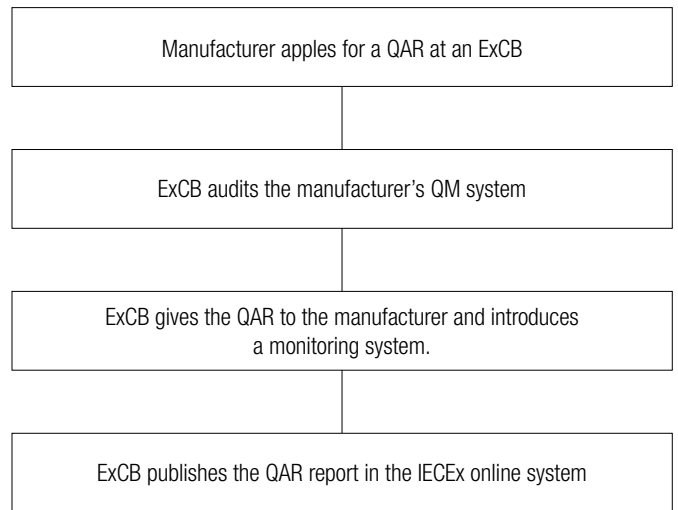

Figure 13

ExCB (Ex Certification Body)

Subject to auditing, recognition; Issues QAR and CoC

ExTL (Ex Testing Laboratory)

Subject to auditing, recognition; Checks compliance with the IEC standards

ExTR (IECEx Test Report)

Prepared by ExTL on the basis of uniform forms, approved by ExCB

QAR (IECEx Quality Assessment Report)

Issued by ExCB following the audit of the manufacturer's QMS

CoC (IECEx Certificate of Conformity)

Design corresponds to IEC standards (ExTR); Production takes place with recognised QMS (QAR)

Comparison of the ATEX and IECEx system

Certification	ATEX Legally required in the EU		IECEx Voluntary in the EU Varying acceptance around the world
Testing and conformity of electrical devices	Category 1 and 2: <ul style="list-style-type: none"> ■ Recognised QA system ■ EU-type examination certification ■ EU Declaration of Conformity ■ CE marking 	Category 3 <ul style="list-style-type: none"> ■ Internal in-process inspection ■ EU Declaration of Conformity ■ CE marking 	Equipment protection level (EPL a, b, c) <ul style="list-style-type: none"> ■ Quality Assessment Report (QAR) ■ Test Report (ExTR) ■ Certificate of Conformity (CoC) ■ Marking
Testing and conformity of non-electrical devices	Category 1 <ul style="list-style-type: none"> ■ Recognised QA system ■ EU-type examination certification ■ EU Declaration of Conformity ■ CE marking 	Category 2¹⁾ and 3 <ul style="list-style-type: none"> ■ Internal in-process inspection ■ EU Declaration of Conformity ■ CE marking <p>¹⁾ Submission of the technical documentation to a notified body</p>	Equipment protection level (EPL a, b, c) Not conclusively settled yet. Expected to be the same as with electrical devices Basic standards: ISO 80079-36 and -37
Certificates	Manufacturer (oft online)		IECEx online database
Repair workshops	No EU-certified workshops (regulated on a national level)		Certified Service Facilities
Service personnel	No EU-certified persons (regulated on a national level)		Certified competent persons
Zone classification	No EU-certified bodies (regulated on a national level)		Certified Service Facilities (under development)

Table 14

For further information on explosion protection

please have a look at the **Ex protection information** section at <http://www.bartec.de/safet-academy>

BARTEC

Your partner
for safety
technology.
Challenge us!

